

ORTOLAN

SERIES SM



Fresatrice interrassassi serie SM per trattori da 130 a 220 CV

Fresatrice interrassassi molto pesante e robusta concepita per lavorare grandi appezzamenti di terreno, in particolar modo terreni sassosi allo scopo di migliorarne la loro preparazione. Questo modello raggiunge profondità di lavoro elevate e durante la lavorazione, grazie ad uno speciale sistema di selezione, le pietre presenti nel terreno vengono deposte sul fondo mentre sopra ricade lo strato di terriccio setacciato. Disponibile in 4 modelli nelle differenti misure di lavoro di 250-300-350-400 cm.

Equipaggiamento di serie: riduttore di velocità 1000 giri/min., tendicatena automatico, cardano a frizione di sicurezza, rotore a 6 zappe per flangia (elicoidali), griglia parasassi, attacco universale di 2ª e 3ª categoria e barra livellatrice. Rulli disponibili a rete e packer.

Le caratteristiche tecniche e le immagini possono subire variazioni senza obbligo di preavviso e responsabilità.



BARRA LIVELLATRICE POSTERIORE
REAR LEVELLING BAR
BARRE NIVELEUSE ARRIÈRE
HINTERE PLANIERSCHIENE

RULLO PACKER
PACKER ROLLER
ROULEAU PACKER
PACKER WALZE

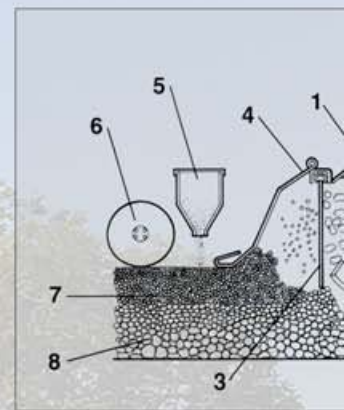

ROTORE RINFORZATO CON DOPPIA FLANGIA
REINFORCED ROTOR WITH DOUBLE FLANGE
ROTOR RENFORCÉ AVEC DOUBLE BRIDE
VERSTÄRKT ROTOR DOPPELFLANSCH

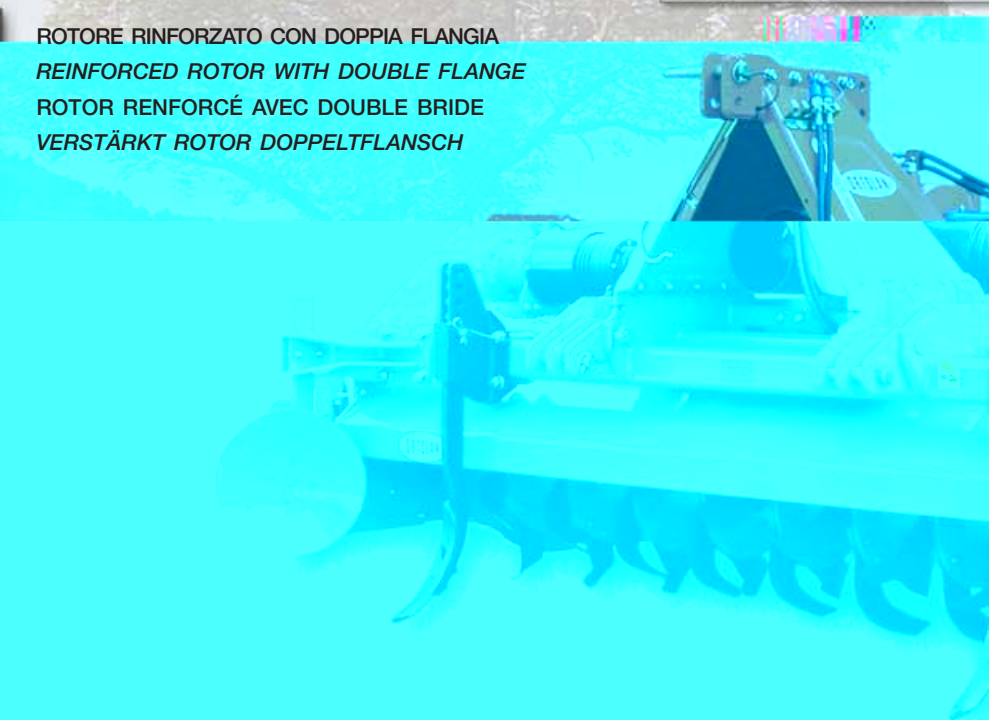

Fraise enfouisseuse de pierres séries SM pour tracteurs entre 130 et 220 CV

Cette fraise très lourde et robuste conçue pour travailler dans des grandes étendues de terrains en particulier les terrains caillouteux, afin d'améliorer leur préparation. Ce modèle permet d'atteindre de grandes profondeurs de travail et une grille spéciale permet de retenir les pierres e les grosses mottes, on les déposant en profondeur et en laissant en surface une couche uniforme de terreau tamisé. Disponible en 4 largeurs de travail: 250-300-350-400 cm.

Equipment standard: boîtier 1000 Tr/mN, tondeur de chaîne automatique, cardan à sécurité friction, rotor à 6 couteaux (hélicoïdal), grille sélection des pierres, attelage points réglable cat. 2ª et 3ª et kit lame niveleuse arrière. Rouleaux disponibles grille et packer.

Les photos et les caractéristiques sont non contractuelles.



Stone burier tiller series SM for tractors between 130 and 220 HP

A very heavy duty model designed for working in large acreage. This model allows to reach elevated working depth and special screening system safely separates and places the stones picked up from the soil underneath the seed bed; fine soil remains on top. 4 Models are available following the working width: 250-300-350-400 cm. Standard equipment: 1000 rpm gearbox, automatic chain stretcher, slip clutch drive, 6 blades per flange (helicoidal) protection steel screen for stones, universal 3 point hitch cat. 2nd and 3rd and levelling bar. Available mesh and packer roller. *Specifications and/or designs are subject to change without notice or obligation.*



RULLO RETE
MESH ROLLER
ROULEAU GRILLE
NETZWALZE

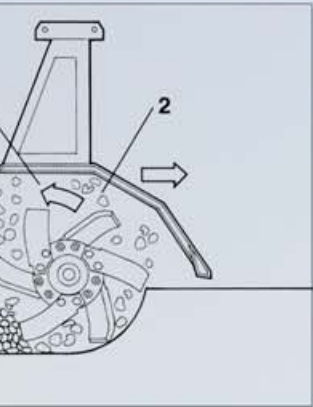

DISCHI RINCALZATORI
COULTER
DISQUE BUTTEUR
HAÜFLER SCHEIBE



ROMPITRACCIA
SUBSOILER
SOUS-SOLEUSE
SPURBRECHER

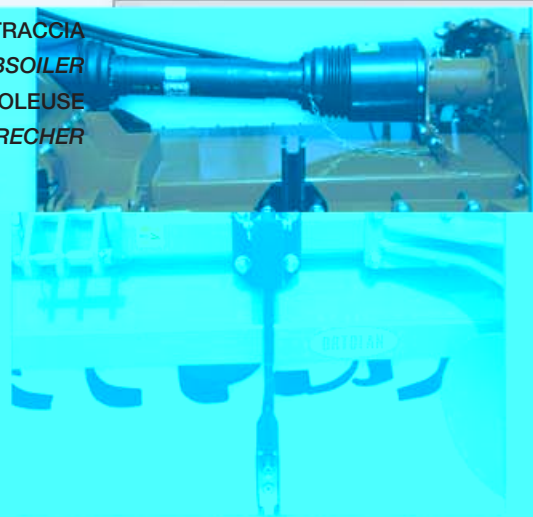







Umkehrfräse Serie SM für Schlepper zwischen 130 und 200 PS

Diese schwere und robuste Bodenfräse wurde zum arbeiten auf steinigem Gelände und zur Erleichterung der Vorbereitung des Bodens geplant. Dieses Modell ermöglicht eine beträchtliche Arbeitstiefe und mit einer Spezialvorrichtung, werden sie Steine tief in den Boden vergraben und mit einer Schicht gesiebter Gartenerde bedeckt. Verfügbar in 4 Modellen Arbeitsbreiten 250-300-350-400 cm., 1000 Upm Getriebe, Standard Ausstattung: Automatische Kettenspannung, Gelenkwelle mit Rutschkupplung, Rotor mit 6 Messer Flansch, Verstellbare 3 Punkt Kat. 2^a und 3^a und hintere Planierschiene. Modell mit Netz und Packer Walze.

Technische Eigenschaften und Photos sind Unverbindlich und können zu jeder zeit geändert werden.

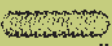

						 HP				
	cm	inch	cm	inch			kg	lbs	kg	lbs
SM 250	247	97	293	115	54	130-220	2000	4410	1900	4190
SM 300	299	118	345	136	66	160-220	2270	5005	2070	4564
SM 350	351	138	357	140	78	180-220	2520	5556	2285	5038
SM 400	403	160	449	177	90	200-220	2800	6173	2500	5512

ORTOLAN

ORTOLAN ZAPPATRICI s.n.c.

Via Lungochiampo, 123/A - 36054 MONTEBELLO (VI) - Italy

Tel. +39 0444 649565 - Fax +39 0444 649914

www.ortolan.net • e-mail: ortolan@ortolan.net

